 = 1 sq foot

General Setup Instructions

- Read entire setup instruction manual prior to unpacking parts and pieces.
- The setup instructions are created specifically for this configuration.
- Setup instructions are laid out sequentially in steps, including exploded views with detailed explanation for assembly.

Cleaning & Packing

- For Cleaning Metal, Plex, & Laminate Parts: Use a **MILD NON-ABRASIVE** cleanser and soft cloth/paper towel to clean all surfaces.
- Keep exhibit components away from heat and prolonged sun exposure. **Heat and UV exposure will warp and fade components.**
- Retain all provided Packing Materials. All provided packing materials are for ease of repacking & component protection.

Disassembly

- For loss prevention, tighten all set screws and locks during disassembly.

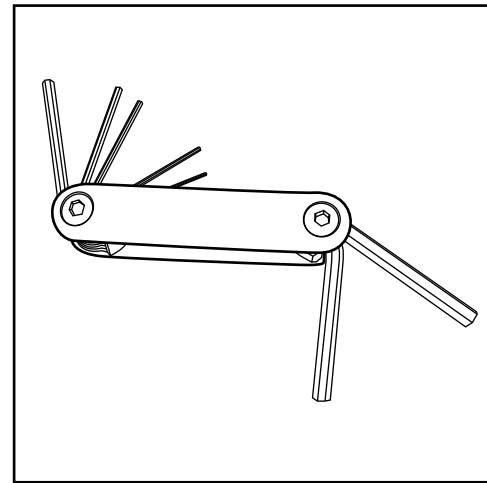

Hex Tool - Essential for Assembly

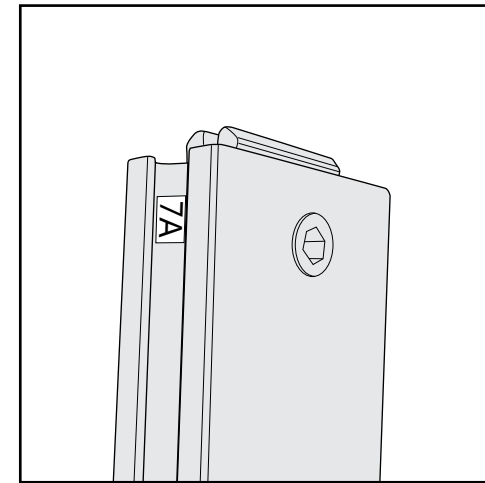

Part Identification - Numbering



Spline Connection



Base Plate & Extrusion Connection



Extrusion & Lock Connection



Engaged Lock



WARNING

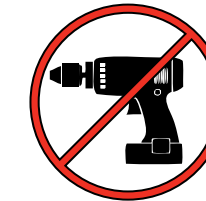

DO NOT USE POWER TOOLS

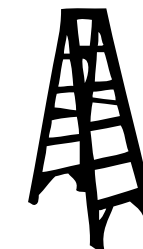

LADDERS OR LIFTS
MAY BE REQUIRED



ALL CONNECTIONS MUST
BE TIGHTLY SECURED

Side-by-Side Assembly

- 1) Frames: Place frames side-by-side with one higher than the other, then slide panel down to lock panels securely together.
- 2) Corner Connectors: Repeat Step 1 for installing corner connectors to frames.

Side-by-Side Disassembly

- 1) Pull pin lock outwards to disengage.
- 2) Pull frames upward and apart at the same time to detach.

Assembly

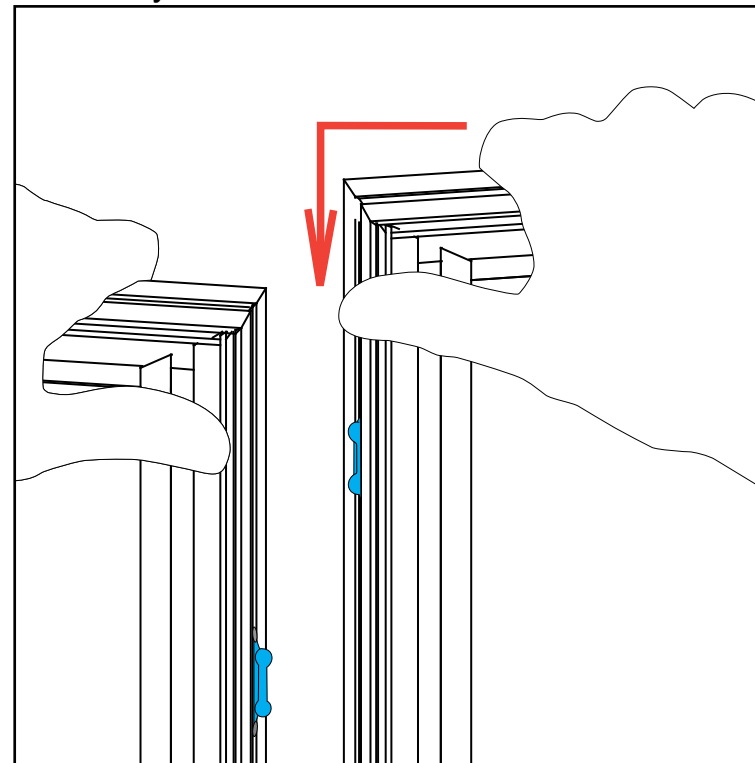

Assembly Cont'd

Push pin lock into hole of connecting frame.
Note: Block of pin lock will secure in groove.

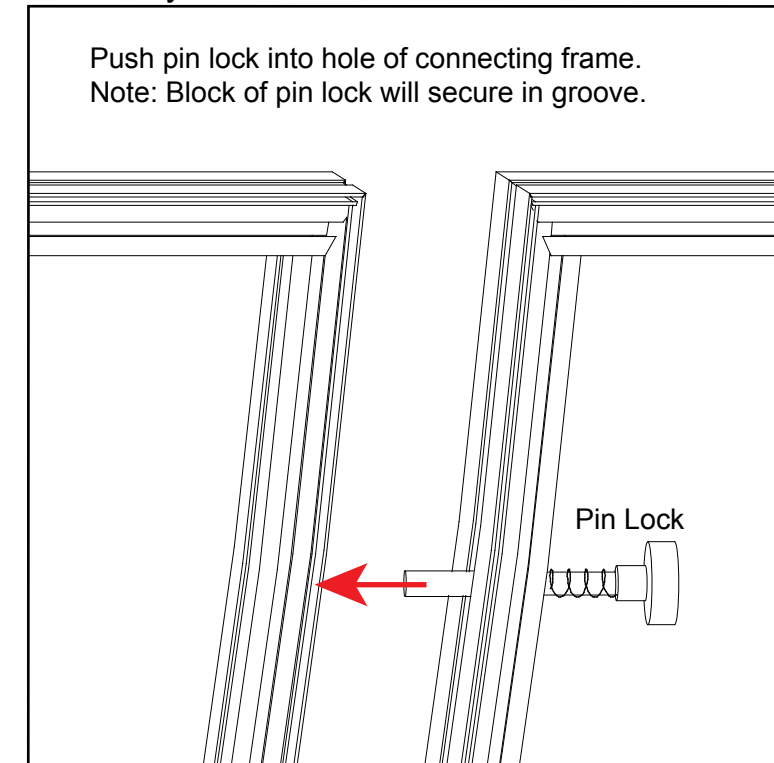

Corner Connector

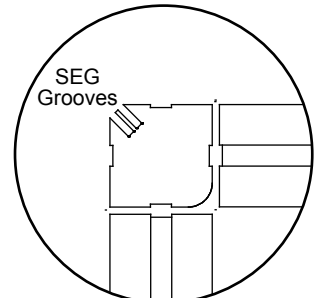

Top View

Note: Orientation of Corner Connector may change.

Stacking Assembly

- 1) Place one horizontal frame on top of the other, lining up the center grooves.
- 2) Turn stacking lock clockwise to tighten into place. Repeat for each lock.

Stacking Disassembly

- 1) Turn the stacking lock counter-clockwise to loosen.
- 2) The whole spring on the stacking lock should be in view to release each frame. The disengaged spring should release the stacking lock. If not, keep turning the stacking lock until it disengages.

Stacking

Push stacking lock into the slot of the upper frame, then spin the cap to tighten the lock.

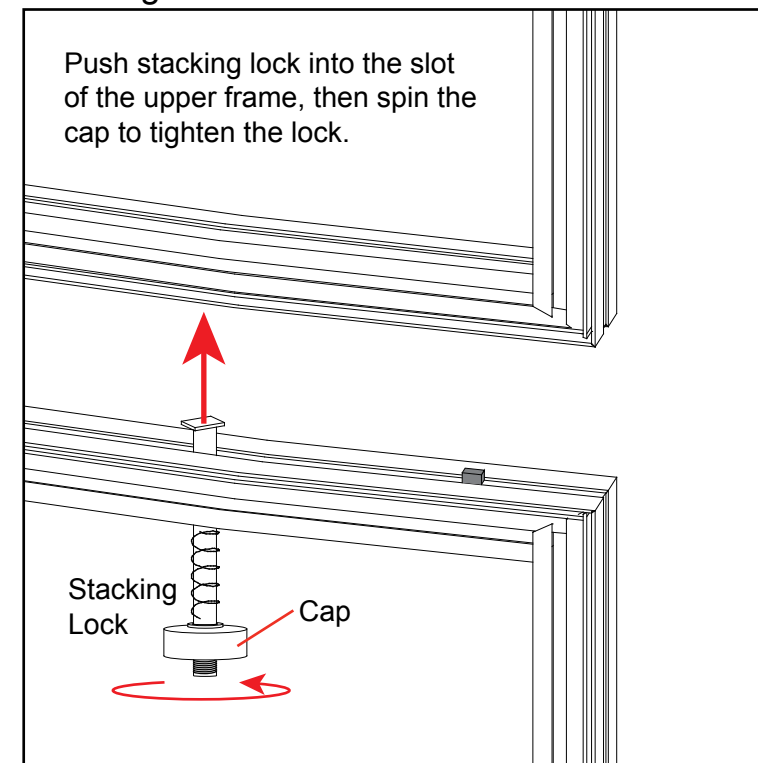

Unstacking

Disengage the stacking lock by spinning the cap counter clockwise and pulling down.

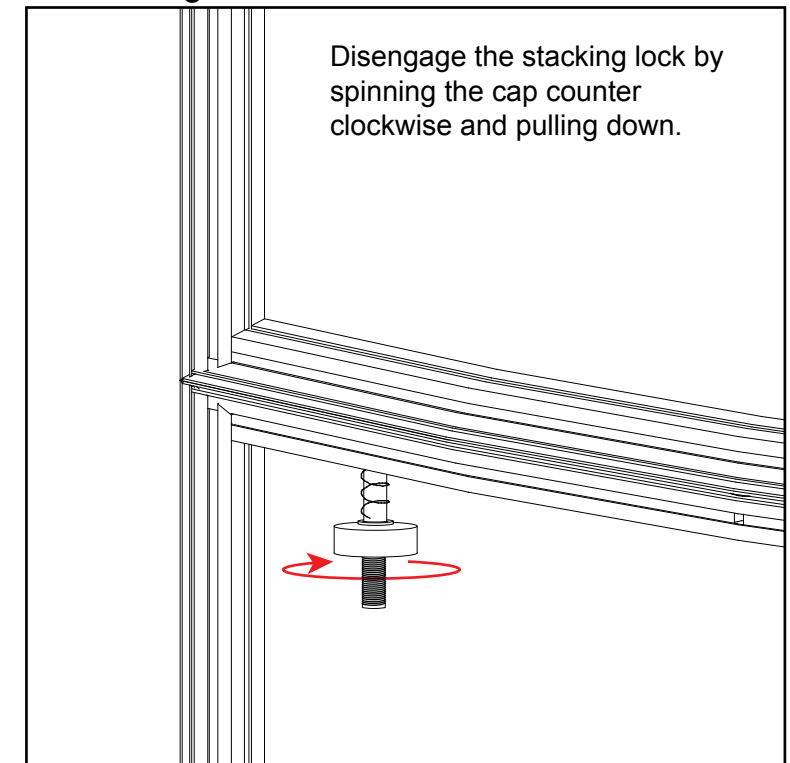

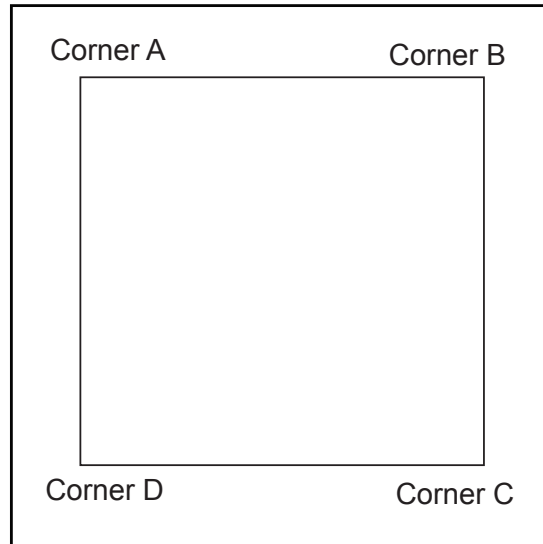

It is important to first insert graphic into each alternate corner then to the sides of the frame. If this is not done, graphic will not fit into the frame correctly.

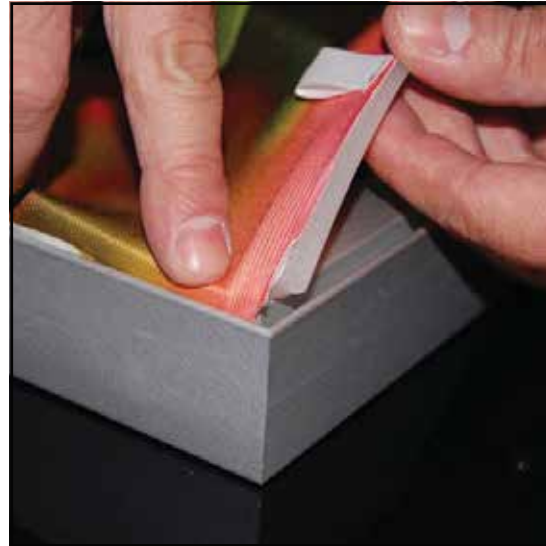

Step 1
Insert corner A. Turn edge of graphic so silicon welt is perpendicular to face of graphic. Insert narrow side of welt with fabric to outside into the channel. Repeat for other side of this corner.



Step 2
Repeat Step 1 for opposite corner C, then insert corner B, followed by corner D, to complete the installation of the corners.



Step 3
Once all corners are inserted, press one silicon edge into channel from corners and work toward the center. Make sure welt is fully inserted into channel. Continue until all sides are done. Smooth out edges of graphic.

Graphic Removal

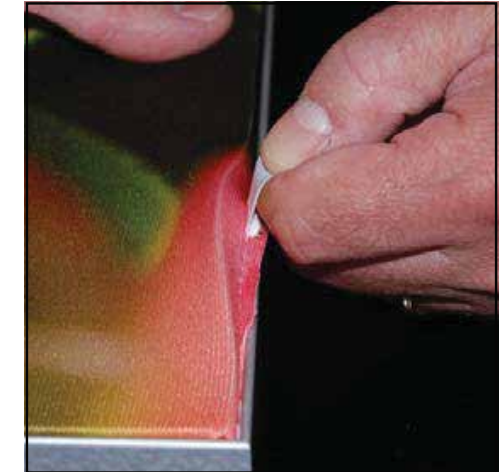

To remove the graphic from the frame, locate the fabric pull tab. Gently pull up on the tab to remove the fabric.

CRATE PACKING

Item	Qty.	Description
1	1	38" w x 95" h Gravitee Panel
2	1	94.5" h Gravitee Corner Post w/ caps
3	1	38" w x 95" h Gravitee Panel
4	1	38" w x 95" h Gravitee Panel
5	1	38" w x 95" h Gravitee Panel
6	1	38" w x 95" h Gravitee Panel
7	1	94.5" h Gravitee Corner Post w/ caps
8	1	38" w x 95" h Gravitee Panel w/ Door
9	1	38" w x 95" h Gravitee Panel
10	1	94.5" h Gravitee Corner Post w/ caps
11	1	38" w x 95" h Gravitee Panel
12	1	38" w x 95" h Gravitee Panel
13	1	38" w x 95" h Gravitee Panel
14	1	38" w x 95" h Gravitee Panel
15	1	94.5" h Gravitee Corner Post w/ caps
16	1	38" w x 95" h Gravitee Panel

Steps:

Refer to the Gravitee Assembly general information page.

1) Assemble Gravitee panels & posts [1] through [16] in numerical order as shown.

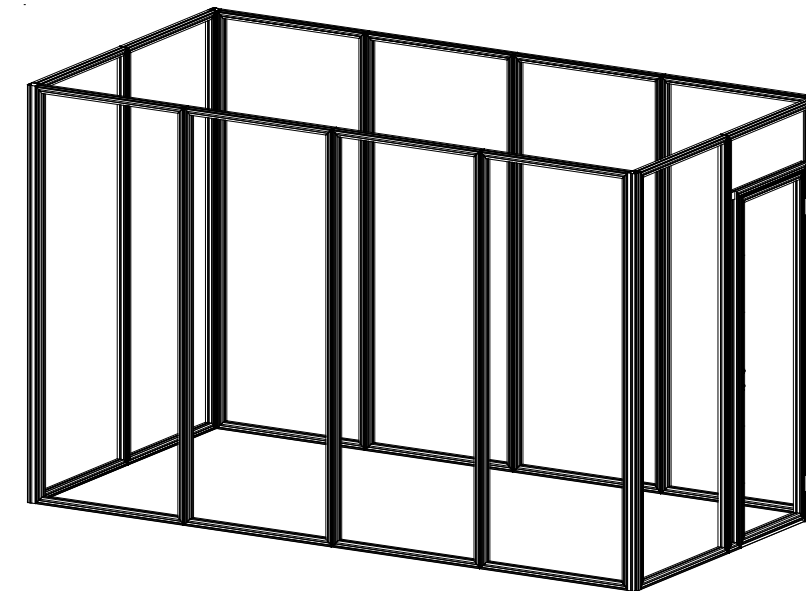

When assembled

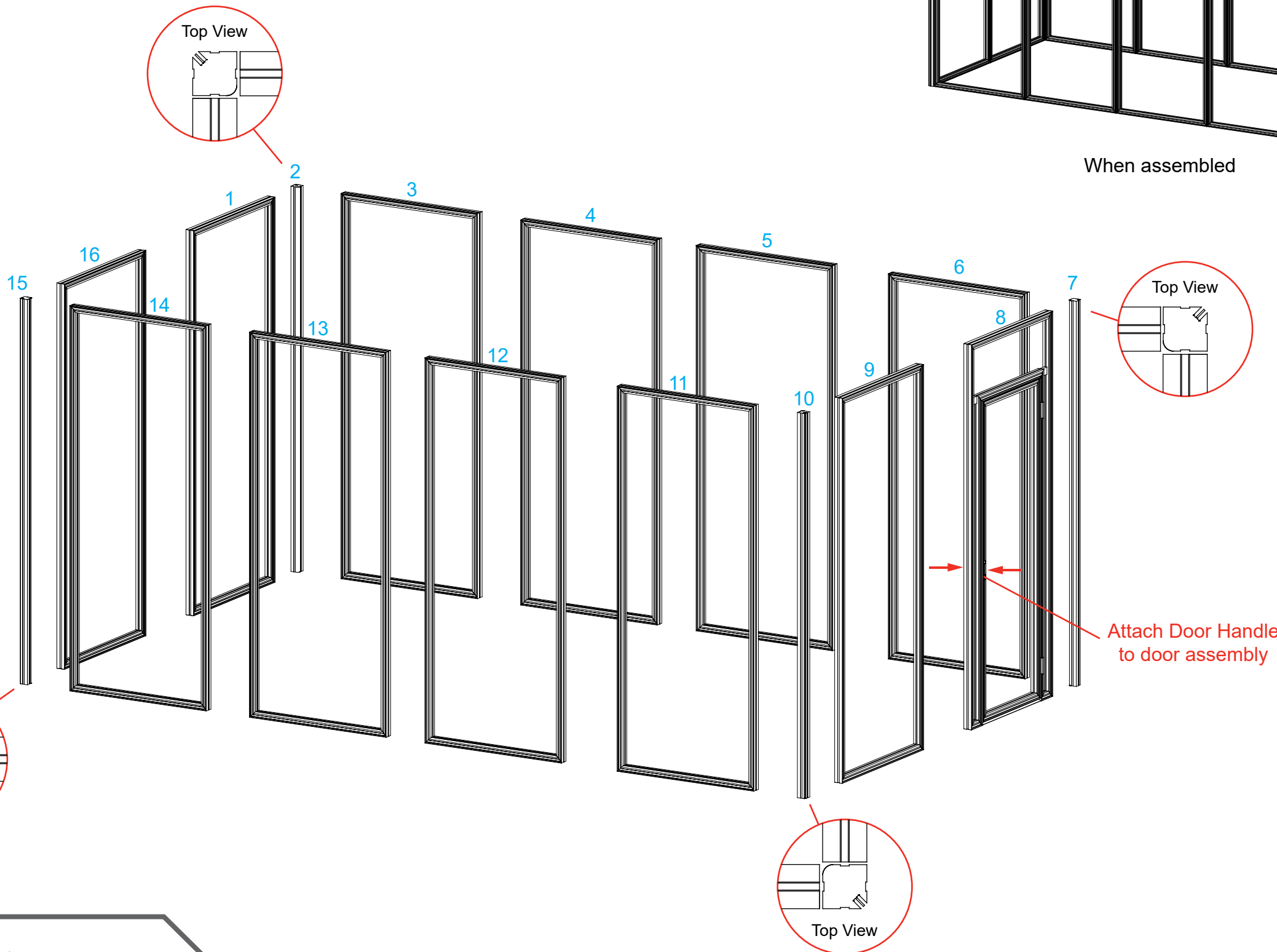

Steps:

Refer to the SEG Installation general information page.

1) Apply SEG graphics to outside face of panels & door.

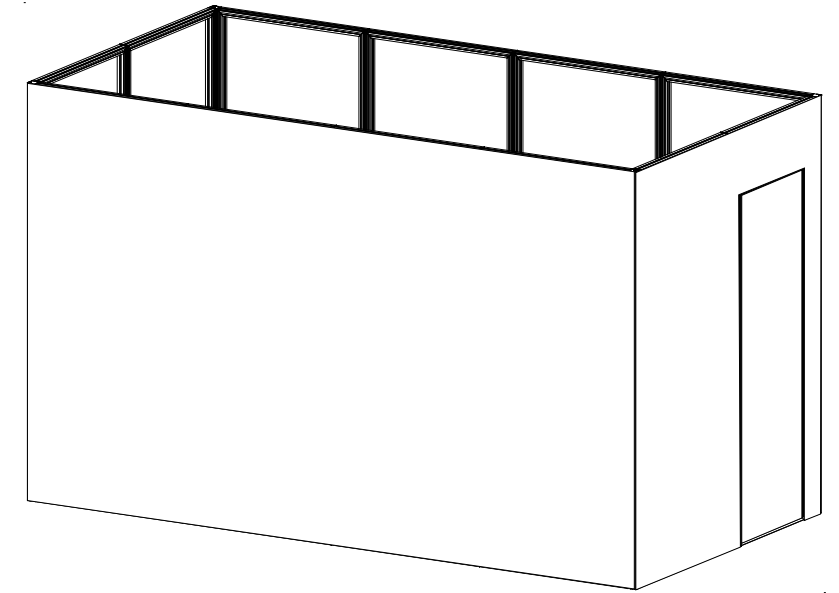
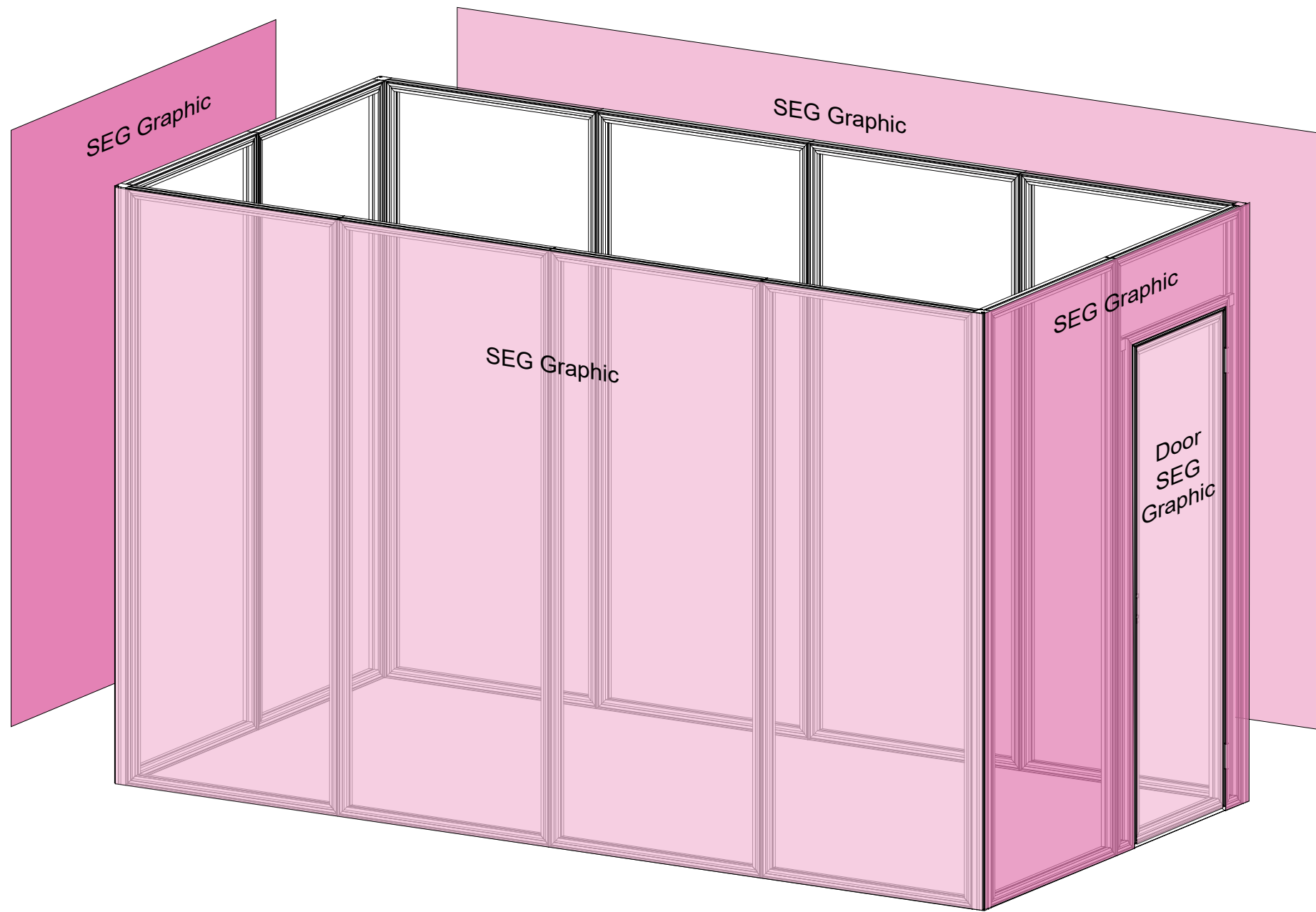

When assembled